

LED Driver

EUCO ARENA SPORT 1.0kW Series

EUCO ARENA SPORT



Highlights & Features

- Dimmable built-in constant current 2-channel LED Driver with DALI 2 or DMX / RDM control interface
- Each channel independently programmable with output channels max output power of 500W (1000W total)
- Adjustable output current between 500mA to 1400 mA for each channel via I-programming tool
- Very low pk-pk current ripple to 1% for stadium lighting
- Dimming range 0.1% to 100 %
- Max remote distance 200 meters
- In compliance with Erp (EU) 2019/2020
- Constant Light Output (CLO) function
- Autonomous dimming via Midnight Centric Timer

Safety Standards



Model Number: EUCO-□□□140G□A
Unit Weight: 5.4kg
Dimensions (L x W x H): 500x152x77 mm

General Description

Delta EUCO ARENA SPORT series with DALI 2 / RDM / DMX control function are constant current non-isolated LED drivers. Compatible with wide input voltage range 220~400Vac for diverse applications from any system manufacturer in EU market's indoor and outdoor application. With IP66 ingress protection and wide operating temperature range from -40°C to +50°, the driver can fulfill any harsh condition. The extremely low output current ripple makes the driver a typical application for outdoor stadium lighting.

Model Information

Model Number	Input Voltage Range	Rated Output Power	Output Current Channel	Control Interface
EUCO-1K0140GLA	220/400Vac Typical	1000W	2	DALI 2
EUCO-1K0140GDA	198~440Vac Range	1000W	2*	RDM/DMX

*Default setting is a single address. Optionally, user could be able to assign a dedicated DMX address per each channel via GUI programming tool.

Model Numbering

EU	C	O	1K0	□□□	G	□	A
Europe	Constant Current	Outdoor	Output power 1K0:1000W	Output Current 140:1400mA	i-Programming	Function L: DALI 2 D: RDM/DMX	Variable A - Standard

LED Driver

EUCO ARENA SPORT 1.0kW Series

Specifications

Model Number	EUCO-1K0140GLA	EUCO-1K0140GDA
--------------	----------------	----------------

Input Ratings / Characteristics

Normal Input Voltage	220/400Vac	
Input Voltage Range	198-440Vac	
Normal Input Frequency	50/60 Hz	
Input Frequency Range	47-63 Hz	
Normal Input Current	220Vac	4.8A
	400Vac	2.7A
Efficiency ¹ Typical	220Vac	95.2%
	400Vac	96%
Standby Power Consumption	<0.5W at 230Vac, in compliance with Erp (EU) 2019/2020	
Inrush Current (Apk / 50%-us)	<=25 A, pulse width<8mS @400Vac	
Power Factor	> 0.95 @ 198-440Vac, full load	
Total Harmonic Distortion	<20% @ 198-440Vac, full load	
Leakage Current	< 1mA @400Vac	

1. 100% Load (Typ) and tested after 30 minutes warming up.

Output Ratings / Characteristics

Factory default output current	1400mA
Output Current Programmable Range	500-1400mA, refer to Appendix 1.
Typical Output Voltage	360Vdc
Output Voltage Range	260-500Vdc
Max. No Load Output Voltage	600Vdc
Max Output Power Range	500W per channel, 1.0kW total
Output Current Tolerance ²	±3%
Line Regulation	±1%
Load Regulation	±3%
Output Current Ripple ³	1% (Typ) ,<2% (ripple = (pk-pk)/avg)
Max Output Remote Distance	200m, ensure a total voltage drop on the cable of each channel within 5V
Turn on Delay Time	< 1s
Rise Time	< 2s

2. Output Current Tolerance tested at 1400mA.

3. Output Current Ripple could be affected by the parasitic capacitance of LED fixture, more details are given in Appendix 8.

Dimming Control

Control Interface	DALI 2	RDM/DMX
Dimming Range	0.1%-100%	0.4%-100%

LED Driver

EUCO ARENA SPORT 1.0kW Series

Model Number	EUCO-1K0140GLA	EUCO-1K0140GDA
---------------------	----------------	----------------

Additional Dimming Features⁴

Smart Timer Dimming (STD)	3 different configurable dimming profiles over the night are available for users to select and set in GUI. This function is not activated by default. Details refer to its GUI manual.
Constant Lumen Output (CLO)	CLO function is to compensate the aging of the light source, resulting in a constant lumen output over the lifetime of the driver. It's available in GUI for the relevant configuration. This function is not activated by default. For more information, please refer to its GUI manual.

4. These are additional features and have been introduced in product since Sept. 2023.

Mechanical

Casing	Aluminum case, dark gray, compliance with C5 environment (ISO 9223)	
Dimensions (L x W x D)	500x152x77 mm	
Unit Weight	5.4 kg	
Cooling System	Natural Convection	
INPUT	With the sign of L, N, PE	
OUTPUT	With the sign of PE, NTC, V3+ V3-, V2+, V2-, V1+, V1-	
DIMMING	With the sign of DA+,DA-	With the sign of COM,D1+,D1-

Environment

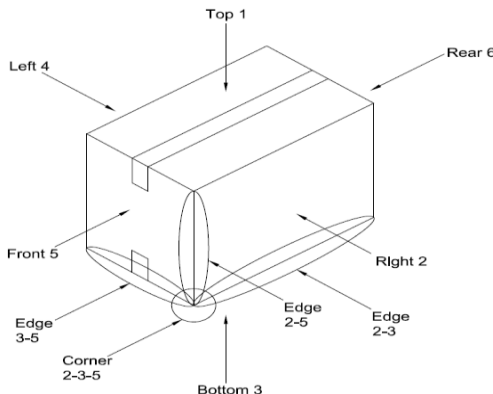
Ambient Temperature	Operating	-40 ~+50°C
	Storage	-40°C to +85°C
Maximum Case Temperature	+75°C	
Lifetime Case Temperature	+70°C	
Relative Humidity	Operating	10 to 95% RH (Non-Condensing)
	Storage	5 to 95% RH (Non-Condensing)
Audible Noise (30cm distance)	Sound Pressure Level (SPL) < 24dBA	
Ingress Protection classification	IP66	
Impact Protection classification	IK08	
Drop Test (Non-Operating)	<p>According to ASTM D-775, 40cm height drop to concrete floor as below drawing, total 10 times.</p> 	
Vibration (Non-Operating)	IEC 60068-2-6, Random: 5 Hz to 10 Hz (1G); 30 min per axis for all X, Y, Z direction	
Packing	1pcs per carton	

LED Driver

EUCO ARENA SPORT 1.0kW Series

Model Number	EUCO-1K0140GLA	EUCO-1K0140GDA
---------------------	----------------	----------------

Protections

Over Voltage	Output voltage limited, 600Vdc
Over Load	Output power limited, 520W(Typ)
Output Short Circuit	Auto-Recovery when the fault is removed
Driver Over Temperature	Output power derating, not less than 20% in the worst case, auto-recovery when the fault is clear.
LED Fixtures Over Temperature	Output power derating, not less than 20% in the worst case, auto-recovery when the fault is clear, refer to Appendix 7 "Over Temperature Protection on LED fixtures"
Suitable for Luminaires Class	Class I. Insulation Class according to IEC60598

Reliability Data

Lifetime	50,000 hours applicable for 220Vac to 400Vac(50/60Hz) @100% of load, @ ta 45°C
MTBF	475khrs. at ta=+45°C Telcordia SR-332

Safety

Safety Approvals	<p>ENEC —IEC/EN61347-2-13 electronic control gear for LED Modules, independent type. —IEC/EN62384 DC or AC supplied electronic control gear for LED modules.</p> <p>CE Declaration of Conformity. UL/CCC Compliant only. CB report.</p>
Material and Parts	RoHS 2.0 Directive (EU) 2015/863
Isolation	Class I, input/output non-isolation

Electro-Magnetic Compatibility (EMC)

EMC-Emission Characteristics		
Radiated Emission	EN55015	Test at 230Vac/400Vac
Conducted Emission	EN55015	Test at 230Vac/400Vac
Harmonic Current Emission	EN61000-3-2	
Voltage Fluctuation & Flicker	EN61000-3-3	
EMC-Immunity Characteristics		
Electrostatic Discharge(ESD)	EN 61000-4-2	
Radio Frequency Electromagnetic Fields	EN 61000-4-3	
Electrical Fast Transient (EFT)	EN 61000-4-4	
Surge(AC Mains)	EN 61000-4-5	- Common Mode: 10kV ⁵ (Line to Earth, Neutral to Earth) - Differential Mode: 10kV ⁵ (Line to Neutral)
Surge(Output)	EN 61000-4-5	- Common Mode: 3kV (V1+/V2+ to Earth, V1-/V2- to Earth) - Differential Mode: 1kV (V1+ to V1-/ V2+ to V2-)
Surge(Control terminal)	EN 61000-4-5	- Common Mode: 3kV (DA+ to Earth, DA- to Earth) - Common Mode: 3kV (D1+ to Earth, D1- to Earth, COM to Earth) - Differential Mode: 1kV (DA+ to DA-) - Differential Mode: 1kV (D1+ to D1-, D1+ to Com,D1- to Com)

LED Driver

EUCO ARENA SPORT 1.0kW Series

Surge(NTC)	EN 61000-4-5	- Common Mode: 3kV (NTC to Earth) - Differential Mode: 1kV (NTC to V1+/V2+)
Conducted Disturbance	EN61000-4-6	
Voltage Dip & Interruptions	EN 61000-4-11	

5. Level B within three times, additional external SPD in AC mains is recommended for the LED fixture common mode surge protection, details refer to Appendix 10.

Miniature Circuit Breaker Configuration

The maximum number of LED drivers connectable to a single MCB is recommended in the following table for maximum 1000W and each nominal input voltage. Due to the differences in application conditions and different kinds of miniature circuit breakers available on the market, this table is just for reference

Circuit Breaker Type	MCB B/C 10A	MCB B/C 16A	MCB B/C 20A	MCB B/C 25A	MCB B/C 32A
Input: 220~240Vac	1	2	2	3	4
Input: 380~400Vac	1	2	2	3	4

Electrical Connection

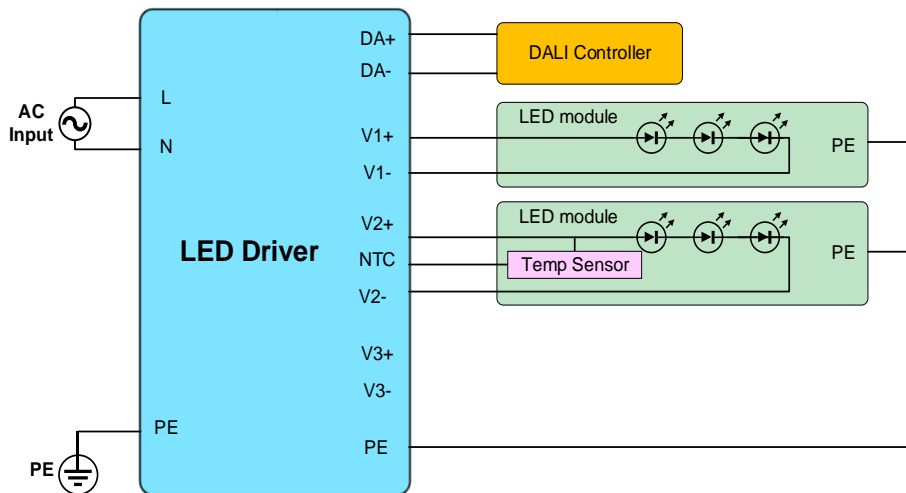

EUCO-1K0140GLA

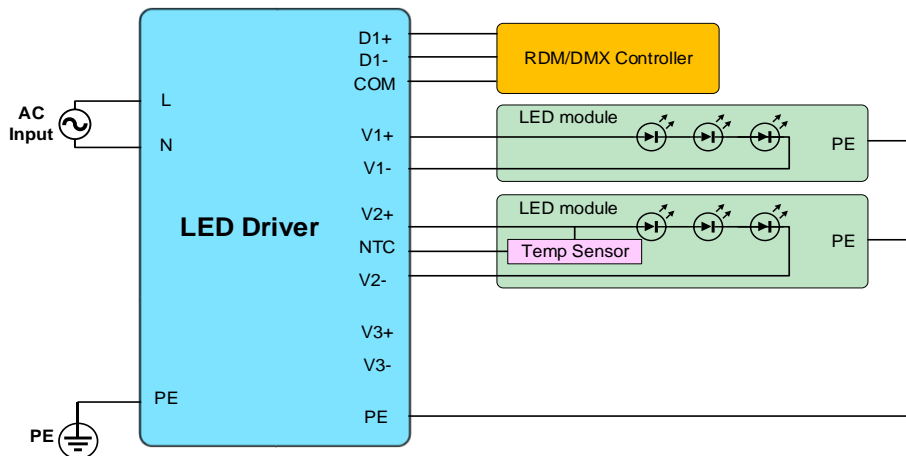

EUCO-1K0140GDA

LED Driver

EUCO ARENA SPORT 1.0kW Series

Note: All the output channels are independent. The user should follow the Connection Schematic. Please refer to Appendix 9 for misconnection examples.

Physical Dimensions

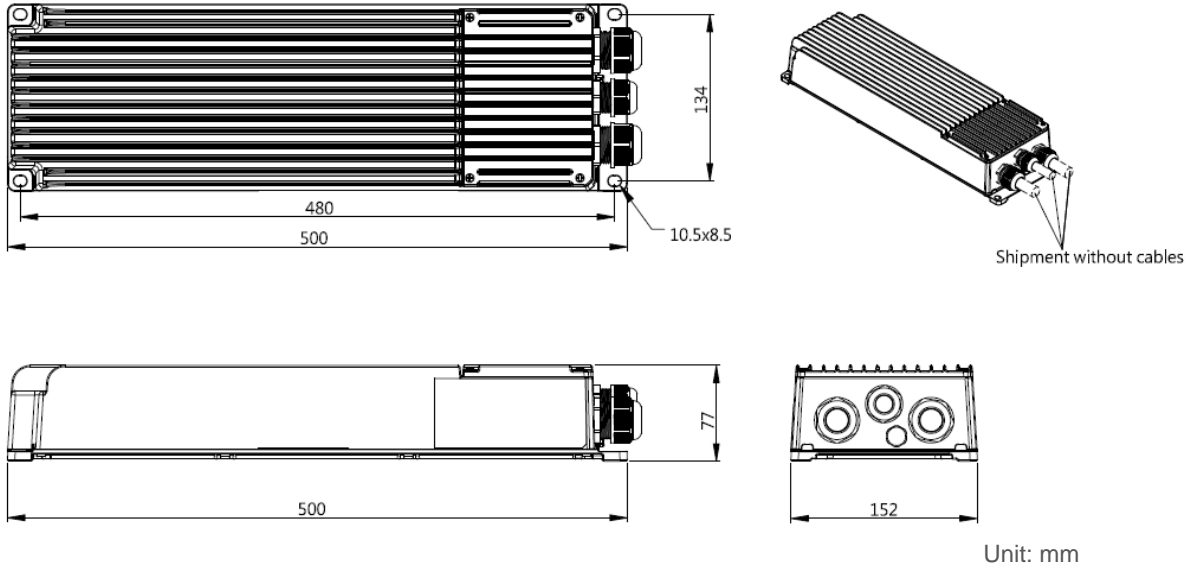

Cable Gland

M25 cable gland to housing: 3.43Nm

M20 cable gland to housing: 3.43Nm

Vent to housing: 0.6~0.8 Nm

⚠ Do not loosen the Protective Vent

Input: M25 cable gland (5 Nm)
Clamping cable: 10.0~16.3mm
1.5~2.5□ AWG 15~12

Control: M20 cable gland, plug by default (1 Nm)

Output: M25 cable gland (5 Nm)

Option A:

Clamping cable (3.5 Nm)
6.3~11.3mm(1 hole seal)
1.0~2.5□ AWG 17~12



Default:

Clamping cable (5 Nm)
10~16.3mm(1 hole seal)
1.0~2.5□ AWG 17~12



Option B:

Clamping cable (3.5 Nm)
5.0~6.5mm(2 holes seal)
0.3~2.5□ AWG 22~12

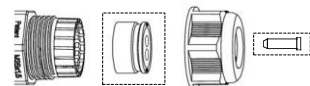

The 2 holes seal and plug are in the plastic bag.

Optional:

Clamping cable (5 Nm)
5.0~6.5mm(2/3 holes seal)
0.3~2.5□ AWG 22~12

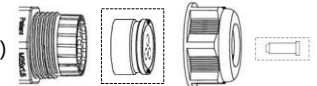

The 2/3 holes seal and plug are in the plastic bag.

LED Driver

EUCO ARENA SPORT 1.0kW Series

Junction Box

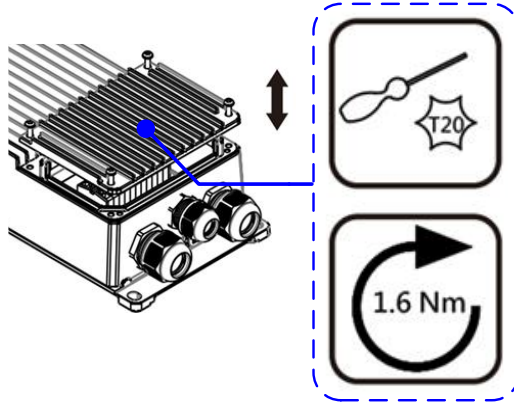

Note: The cap and fastening 4 screws all have the function of anti-falling off.

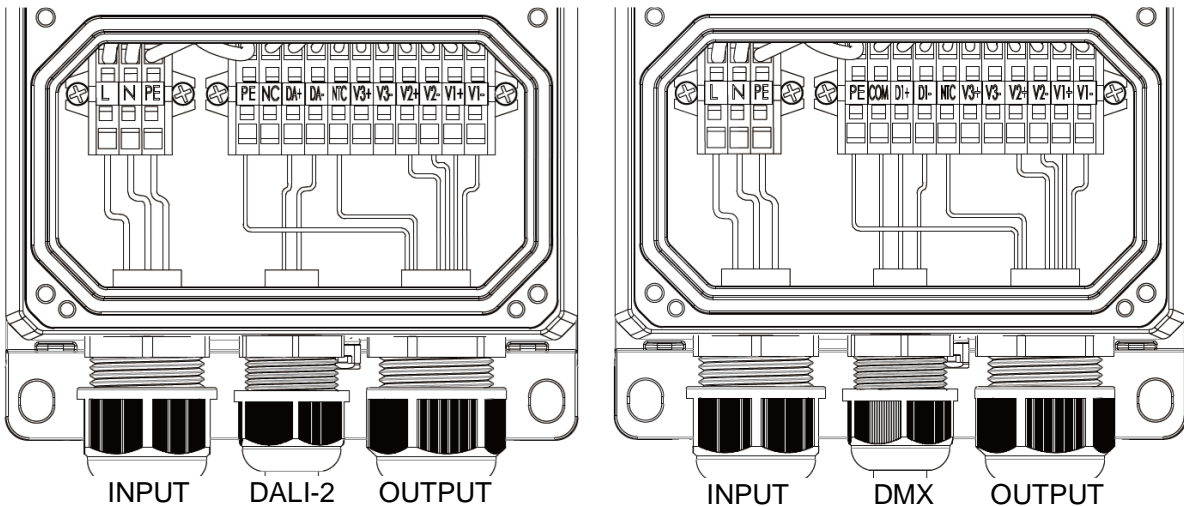

Number	Label	Description
1	L	AC input
2	N	AC input/Neutral
3	PE	Protective Earth
4	PE	Protective Earth for luminaire
5	NC	No Connection
	COM	DMX Common port/Shielding
6	DA-	DALI signal -, and the ground of "+24V"
	D1-	DMX signal -
7	DA+	DALI signal +
	D1+	DMX signal +
8	NTC	Luminaire Temperature Detection
9	V3+	No Connection
10	V3-	No Connection
11	V2+	Channel 2 output +
12	V2-	Channel 2 output -
13	V1+	Channel 1 output +
14	V1-	Channel 1 output -

LED Driver

EUCO ARENA SPORT 1.0kW Series

Appendix

1. Operating Range Curve

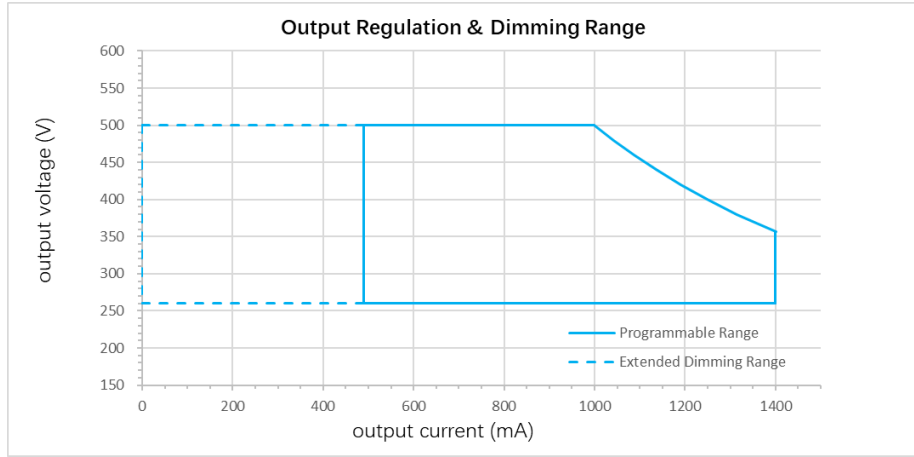

2. Dimming Range Curve

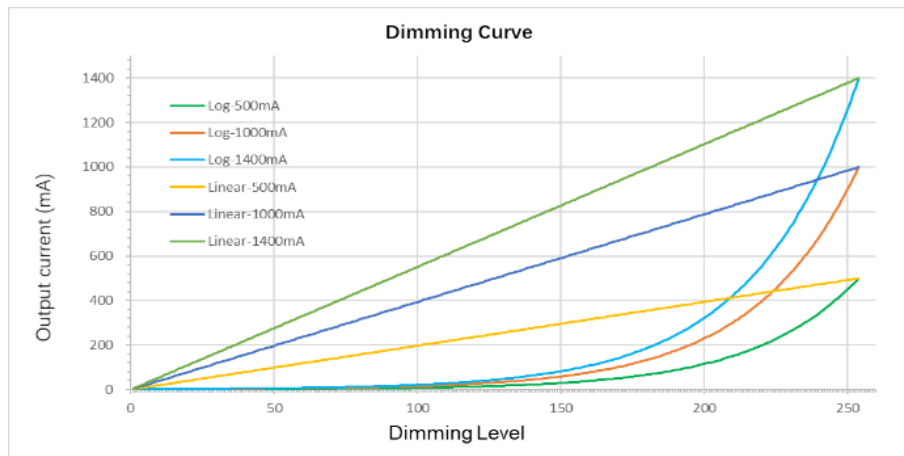

Note: EUCO ARENA SPORT series can program the output current through computer and programming tool. More details please refer to DALI programming User Manual or RDM/DMX programming User Manual.

3. Life Time VS Case Temperature Curve

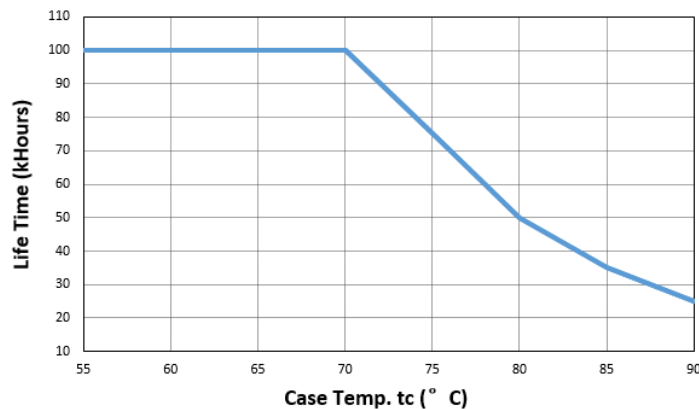

Note: Test at input voltage 220Vac & 400Vac, at full Load with 1.4A/360V.

LED Driver

EUCO ARENA SPORT 1.0kW Series

4. Efficiency versus Output Power

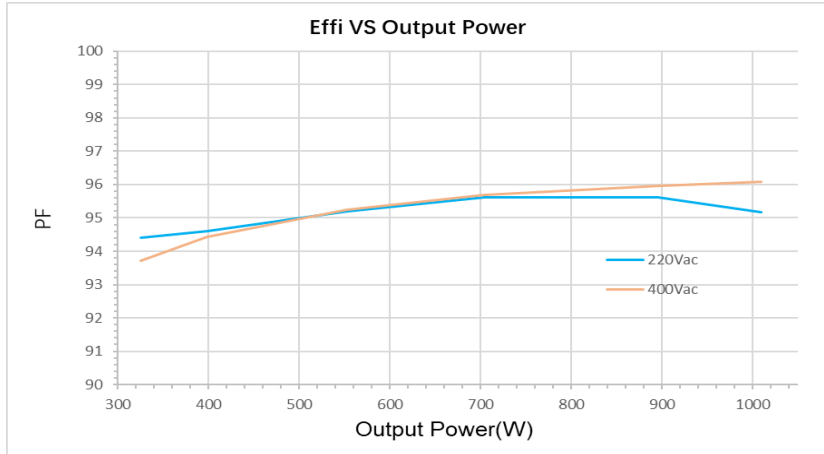

5. Power Factor versus Output Power

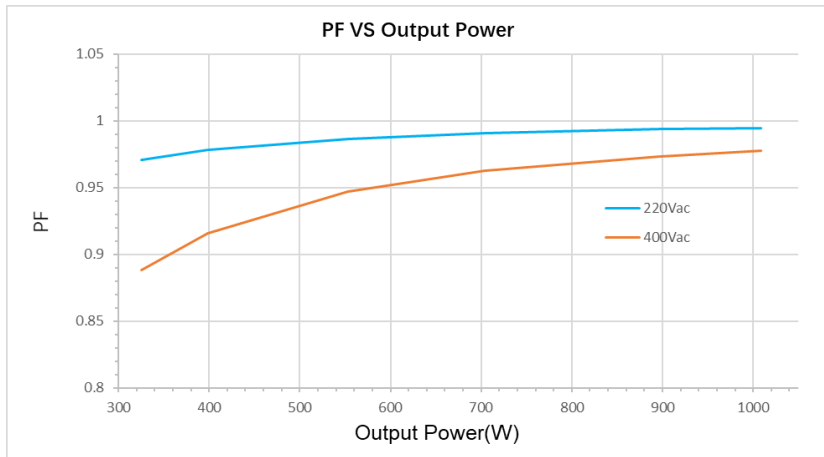

6. THD versus Output Power

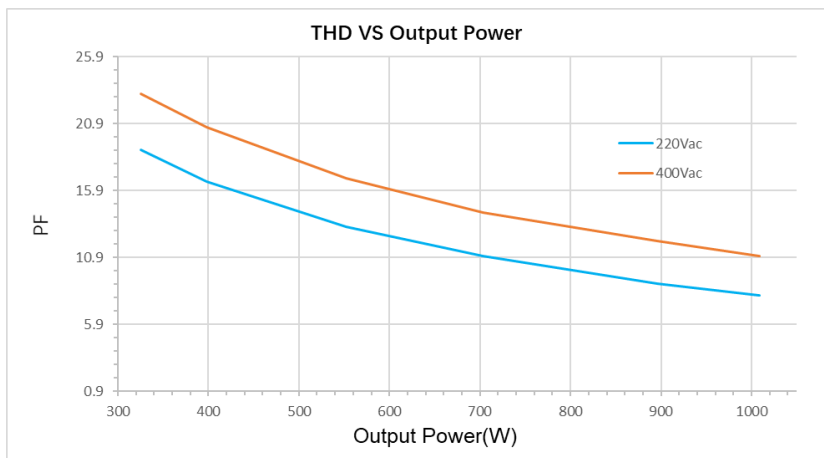

LED Driver

EUCO ARENA SPORT 1.0kW Series

7. Over Temperature Protection on LED Fixtures

This protection is an optional feature and user can ignore it without connecting to NTC connector in the junction box. An external temperature detection circuit as shown below is required to achieve the NTC terminal function to prevent the LED fixture from overheating. Strongly recommended that the temperature detection circuit be placed on the hottest LED module in the three channels to monitor its temperature.

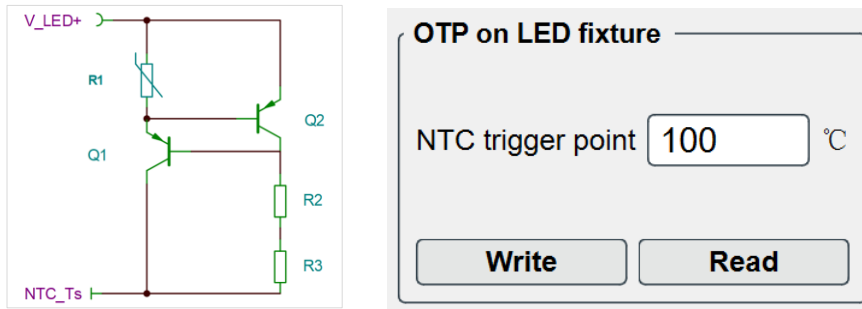

Bill of recommended materials

Reference	Part	Manufacturer	Description
Q1/Q2	PBHV9050T	NEXPERIA	500V 150 mA PNP high-voltage low VCEsat transistor
R1	TSM1A333F3952RZA	THINKING	RES NTC 33Kohm F 3950K +/-1% SMD 0603 TP
R2/R3	RC1206FR-07 5M1L	YAGEO	RES SMD 1/4W 5.1Mohm F 1206

The trigger point of this protection can be set easily according to the actual conditions of the LED fixtures, the user can set the trigger point between 80 °C and 110 °C by the tool (from Delta), and the default value is 100 °C. When the temperature exceeds the trigger point (T_{OTP}), the output current of each channel will decrease automatically within 10 seconds to bring the temperature of the LED module back to safe value. Note that the temperature measurement accuracy depends on the load condition. More details about parameter setting please refer to DALI programming User Manual or RDM/DMX programming User Manual.

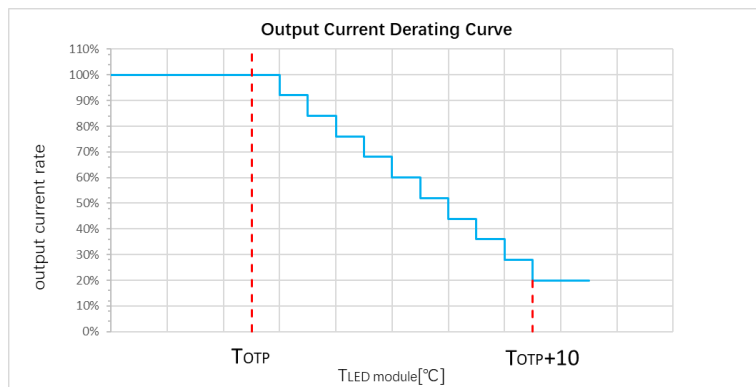

8. Effect of Parasitic Capacitance in LED Fixture

The simplified structure of LED fixtures and leakage current effect are illustrated as following figures. As the driver is non-isolated between input and output, there could be an inevitable leakage current path through LED and equivalent parasitic capacitor C_p (C_{p1} and C_{p2}) to the PE (protective earth) in case that Heat Sink of the LED fixture grounds to the PE. This leakage current i_p could impact on the output current ripple and the performance at low dimming level or dimming OFF. The equivalent C_p should be kept as low as possible for low leakage current and accordingly optimized performance of the driver.

LED Driver

EUCO ARENA SPORT 1.0kW Series

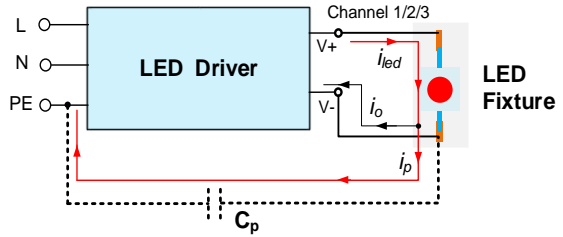
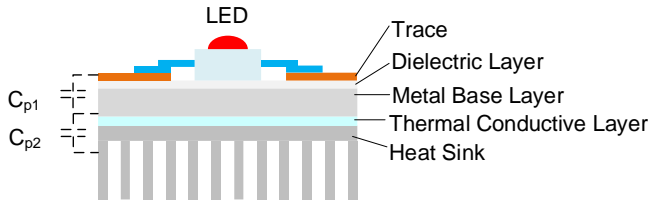

9. Misconnection Warning

Since the output channels of the driver are independent with each other, any wiring misconnection should not be allowed, otherwise the driver could perform abnormally or even fail after a period of operation. Following are some examples of misconnections.

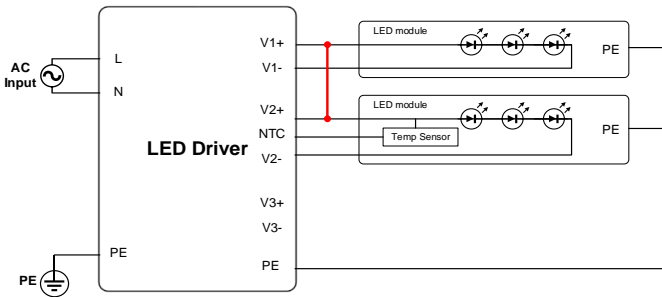

Misconnection of all 2 output positive terminals together.

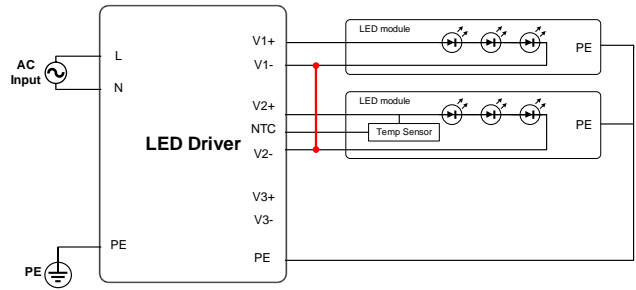

Misconnection of all 2 output negative terminals together.

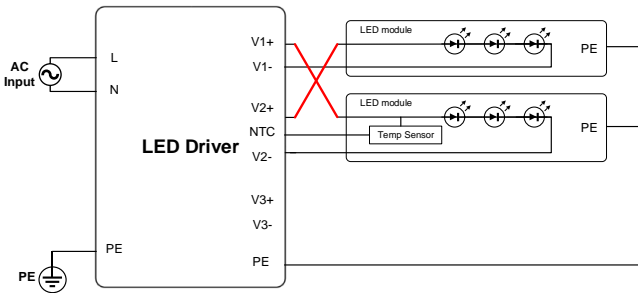

Cross misconnections between all 2 channels.

10. External SPD requirement for extra LED fixture common mode surge protection

Although the EUCO Arena Sport driver features the common mode surge protection capability of 10kV against unexpected surge pulses like Lightning phenomenon through AC mains. The peak of residual common mode voltage pulses between the LED+ and PE or LED- and PE terminals of the luminaire could still be around or over 5kV, an unexpected surge pulses possibly will damage the safety insulation in the LED module board (LED+/- to PE). In addition, in the event the LED module heat-sink insulation is not robust enough, the driver possibly will get damaged due to the high common mode short circuit current induced by the LED board insulation breakdown. Therefore, Delta Electronics proposes for Class I luminaire to install an external surge protector device (SPD) in the AC mains side to improve the robustness surge capability of the luminaire against unexpected surge pulses. In such way, the luminaire would retain a strong common mode surge residual voltage within LED modules capability and it can be easily marketed globally by attributing different surge protector device (SPD) to meet differing surge level requirements.

11. Warranty Policy

Please reach out our [Warranty Policy](#) should you require any further clarification.