

PJ 2nd Generation Open Frame Power Supply

PJ-100W series 1 Phase / PJ-□□V100W□RA

PJ 2nd Gen.

Highlights & Features

- **200% Power Boost** New
- **Comply with JAPAN DEN-AN** New
- **Built-in Remote ON/OFF** New
- Low profile design
- Low Inrush Current / Low Leakage Current
- High efficiency and power factor to conserve energy
- Conforms to harmonic current IEC/EN/BS EN 61000-3-2, Class A
- Conformal coating on PCBA to protect against chemical and dust pollutants
- Versatile configuration options: Open Frame & Enclosed

Safety Standards



CB Certified for worldwide use

Model Number:	PJ-□□V100W□RA
Unit Weight:	Open Frame: 0.22 kg (0.49 lb) Enclosed: 0.38 kg (0.84 lb)
Dimensions (L x W x H):	Open Frame: 155 x 62 x 27 mm (6.10 x 2.44 x 1.06 inch) Enclosed: 185 x 72 x 45 mm (7.28 x 2.83 x 1.77 inch)



General Description

New 2nd generation PJ series of Open Frame Power Supply design with low profile (27mm) and built-in Power Boost of 200% for 10 seconds enables reserve power to be always available for reliable startup of loads with high inrush current, thus eliminating the need of a more expensive power supply unit at higher power rating. Other features include low leakage / Inrush current / remote on/off control and conformal coating on the PCBAs to provide protection against dust and chemical pollutants. Metal chassis and case cover are available as options for different installation preferences. New PJ series conforms to major international safety standards according to EN/UL 62368-1 standards and are fully compliant with compliance with Japan PSE (DEN-AN).

Model Information

PJ Open Frame Power Supply

Model Number	Input Voltage Range	Rated Output Voltage	Rated Output Current
PJ-□□V100W□RA	85-264 Vac (120-373Vdc)	12 Vdc	8.5 A
		24 Vdc	4.3 A
		48 Vdc	2.1 A

Model Numbering

PJ –	□□V	100W	□	R	A
PJ Series	Output Voltage 12 – 12V 24 – 24V 48 – 48V	Output Power	Product Type D – 2nd Gen. Open Frame E – 2nd Gen. Enclosed	R - With Remote ON/OFF	Delta Standard

PJ 2nd Generation Open Frame Power Supply

PJ-100W series 1 Phase / PJ-□□V100W□RA

Specifications

Model Name	PJ-12V100W□RA	PJ-24V100W□RA	PJ-48V100W□RA
------------	---------------	---------------	---------------

Input Ratings / Characteristics

Nominal Input Voltage	100-240 Vac		
Input Voltage Range	85-264 Vac		
DC Input Voltage Range	120-373 Vdc		
Nominal Input Frequency	50-60 Hz		
Input Frequency Range	47-63 Hz		
Input Current	1.35 A typ. @ 100 Vac, 0.55 A typ. @ 200 Vac		
Efficiency at 100% Load	89.0% typ. @ 100 Vac 91.0% typ. @ 200 Vac	89.0% typ. @ 100 Vac 92.0% typ. @ 200 Vac	89.0% typ. @ 100 Vac 93.0% typ. @ 200 Vac
No Load Power Consumption	< 0.5W @100 Vac & 200Vac		
Max Inrush Current (Cold Start)	15 A typ. @ 100 Vac, 30 A typ. @ 200 Vac		
Power Factor Correction at 100% Load	0.99 typ. @ 100 Vac, 0.97 typ. @ 200 Vac		
Leakage Current	0.2 mA @ 100 Vac, 0.4 mA @ 240 Vac		

Output Ratings / Characteristics

Nominal Output Voltage	12 Vdc	24 Vdc	48 Vdc
Factory Set Point Tolerance	± 1% (initial set point tolerance from factory)		
Output Voltage Adjustment Range	10.8-13.2 Vdc	21.6-26.4 Vdc	43.2-52.8 Vdc
Output Current	8.5 A (Io 100%) 17.0 A (Io 200%)	4.3 A (Io 100%) 8.6 A (Io 200%)	2.1 A (Io 100%) 4.2 A (Io 200%)
Output Power	102 W (Normal Max Power 100%) 206.4 W (Power Boost 200% for 10 seconds, refer to the details in the Functions section)	103.2 W (Normal Max Power 100%) 206.4 W (Power Boost 200% for 10 seconds, refer to the details in the Functions section)	100.8 W (Normal Max Power 100%) 206.4 W (Power Boost 200% for 10 seconds, refer to the details in the Functions section)
Line Regulation	± 0.5%		
Load Regulation	± 0.5%		
PARD*1 (20 MHz)	< 150 mVpp @ 0°C to 70°C 450 mVpp typ. @ -30°C to 0°C		< 200 mVpp @ 0°C to 70°C 600 mVpp typ. @ -30°C to 0°C
Start-up Time	500 ms typ. @ 100 Vac (100% load)		
Hold-up Time	30 ms typ. @ 100 Vac (100% load)		
Dynamic Response (Overshoot & Undershoot O/P Voltage)	± 10% @ 115 & 230 Vac input, 10-100% load (Slew Rate: 2.5 A/μS, 50% duty cycle @ 5 Hz & 10 KHz)		
Start-up with Capacitive Loads	8,000 μF Max	8,000 μF Max	5,000 μF Max

*1 PARD is measured with an AC coupling mode, and in parallel to end terminal with 0.1μF ceramic capacitor & 47μF electrolytic capacitor. PSU need to burn in > 5 minutes when AMB ≤ 0°C

PJ 2nd Generation Open Frame Power Supply

PJ-100W series 1 Phase / PJ-□□V100W□RA

Mechanical

Case Cover / Chassis		SGCC
Dimensions (L x W x H)	Open Frame	155 x 62 x 27 mm (6.10 x 2.44 x 1.06 inch)
	Enclosed	185 x 72 x 45 mm (7.28 x 2.83 x 1.77 inch)
Unit Weight	Open Frame	0.22 kg (0.49 lb)
	Enclosed	0.38 kg (0.84 lb)
Indicator		NA
Cooling System		Convection
Terminal	Input	JST B3P5-VH (LF)(SN)
	Output	JST B8P-VH(LF)(SN)
	Remote ON/ OFF	JST B2B-XH-A(LF)(SN)
Wire		AWG 22-18
Noise (1 Meter from power supply)		Sound Pressure Level (SPL) < 25 dBA

Environment

Surrounding Air Temperature	Operating	-40°C to +70°C
	Storage	-40°C to +85°C
Power De-rating	Refer to Engineering Data Fig. 1.1~Fig. 1.4 on Page 8~11	
Operating Humidity	5 to 90% RH (Non-Condensing)	
Operating Altitude	0 to 5,000 Meters (16,400 ft)	
Shock Test (Non-Operating)	IEC 60068-2-27, Half Sine Wave 50G, 11 ms, 3 shocks X, Y, and Z direction	
Vibration (Operating)	IEC 60068-2-6, Sine Wave: 10 Hz to 500 Hz @ 2G; 10 min period, 60 min per axis for all X, Y, Z direction	
Over Voltage Category	II (Compliance to EN 62477-1 OVC III with 2000 meters altitude)	
Pollution Degree	2	

Protections

Overvoltage	14.0-18.0 V, Latch Mode	28.0-36.0 V, Latch Mode	55.0-68.0 V, Latch Mode
Overload / Overcurrent	>201% of rated load current, Hiccup Mode, Non-Latching (Auto-Recovery)		
Over Temperature	Latch Mode		
Short Circuit	Hiccup Mode, Non-Latching (Auto-Recovery when the fault is removed)		
Internal Fuse at L pin	3.15A		
Protection Against Shock	Class I with PE*2 connection		

*2 PE: Protection Earth

Reliability Data

MTBF	> 700,000 hrs. as per Telcordia SR-332
Expected Cap Life Time	10 years (100 Vac, 50% load @ 40°C)

PJ 2nd Generation Open Frame Power Supply

PJ-100W series 1 Phase / PJ-□□V100W□RA

Safety Standards / Directives

Safety Entry Low Voltage		SELV
Electrical Safety	TUV Bauart UL/cUL recognized CB scheme	EN 62368-1 UL 62368-1 and CSA C22.2 No. 62368-1 IEC 62368-1 Design to meet DENAN at 100 Vac
CE		In conformance with EMC Directive 2014/30/EU and Low Voltage Directive 2014/35/EU
UKCA		In conformance with Electromagnetic Compatibility Regulations 2016 and Electrical Equipment (Safety) Regulations 2016
Galvanic Isolation	Input to Output	3.0 KVac
	Input to Ground	2.0 KVac
	Output to Ground	1.25 KVac

EMC

Emissions (CE & RE)		CISPR 32, EN/BS EN 55032, Comply with FCC Title 47: Class B	
Immunity		EN/BS EN 55035	
Electrostatic Discharge	IEC 61000-4-2	Level 4 Criteria A ¹⁾ Air Discharge: 15 kV Contact Discharge: 8 kV	
Radiated Field	IEC 61000-4-3	Level 3 Criteria A ¹⁾ 80 MHz - 1 GHz, 10 V/M with 1 kHz tone / 80% modulation	
Electrical Fast Transient / Burst	IEC 61000-4-4	Level 3 Criteria A ¹⁾ 2 kV	
Surge	IEC 61000-4-5	Level 4 Criteria A ¹⁾ Common Mode ²⁾ : 4 kV Differential Mode ³⁾ : 2 kV	
Conducted	IEC 61000-4-6	Level 3 Criteria A ¹⁾ 150 kHz - 80 MHz, 10 Vrms	
Power Frequency Magnetic Fields	IEC 61000-4-8	Criteria A ¹⁾ Magnetic field strength 30A/Meter	
Voltage Dips and Interruptions	IEC 61000-4-11	100% dip; 1 cycle (20ms); Self Recoverable	
Harmonic Current Emission		IEC/EN/BS EN 61000-3-2, Class A & Class D	
Voltage Fluctuation and Flicker		IEC/EN/BS EN 61000-3-3	
Voltage Sag Immunity SEMI F47 – 0706	80% of 200 Vac 70% of 200 Vac 50% of 200 Vac	160 Vac, 1000 ms 140 Vac, 500 ms 100 Vac, 200 ms	Criteria A ¹⁾ Criteria A ¹⁾ Criteria A ¹⁾

1) Criteria A: Normal performance within the specification limits
 2) Asymmetrical: Common mode (Line to earth)
 3) Symmetrical: Differential mode (Line to line)

PJ 2nd Generation Open Frame Power Supply

PJ-100W series 1 Phase / PJ-□□V100W□RA

Block Diagram

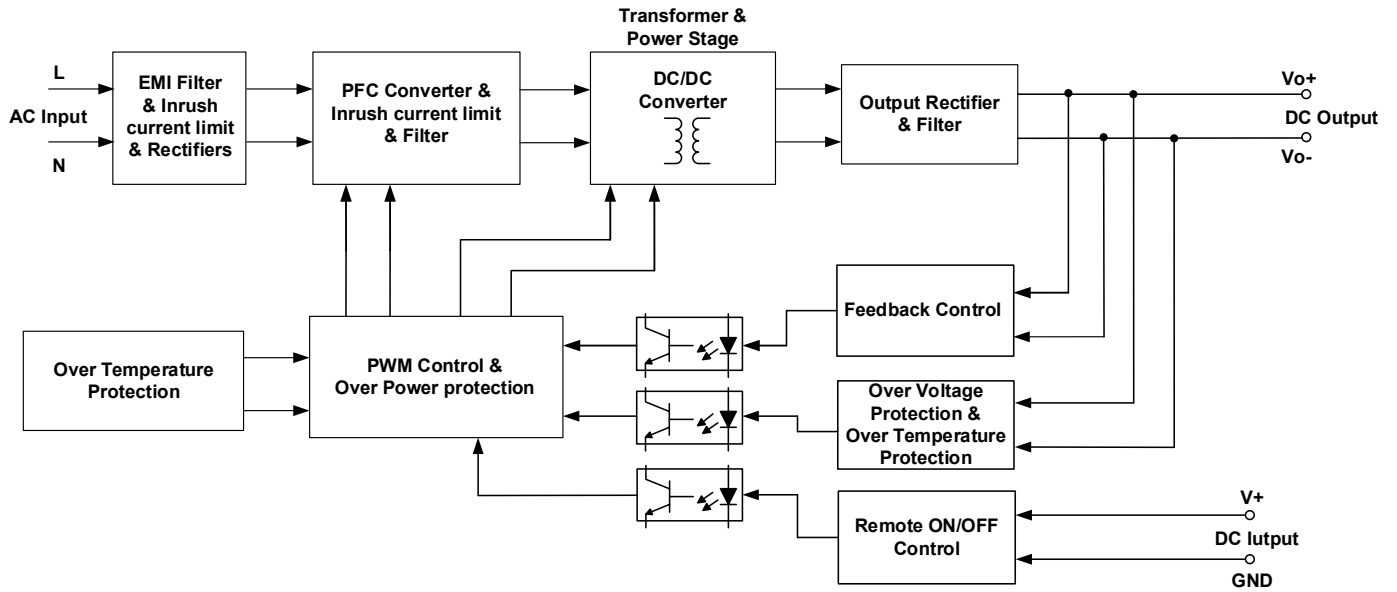

PJ 2nd Generation Open Frame Power Supply

PJ-100W series 1 Phase / PJ-□□V100W□RA

Dimensions

Open Frame

L x W x H: 155 x 62 x 27 mm (6.10 x 2.44 x 1.06 inch)

∅3.7[0.146"] (MOUNTING HOLE)

PE: MUST CONNECT WITH SYSTEM PROTECTIVE EARTHING.

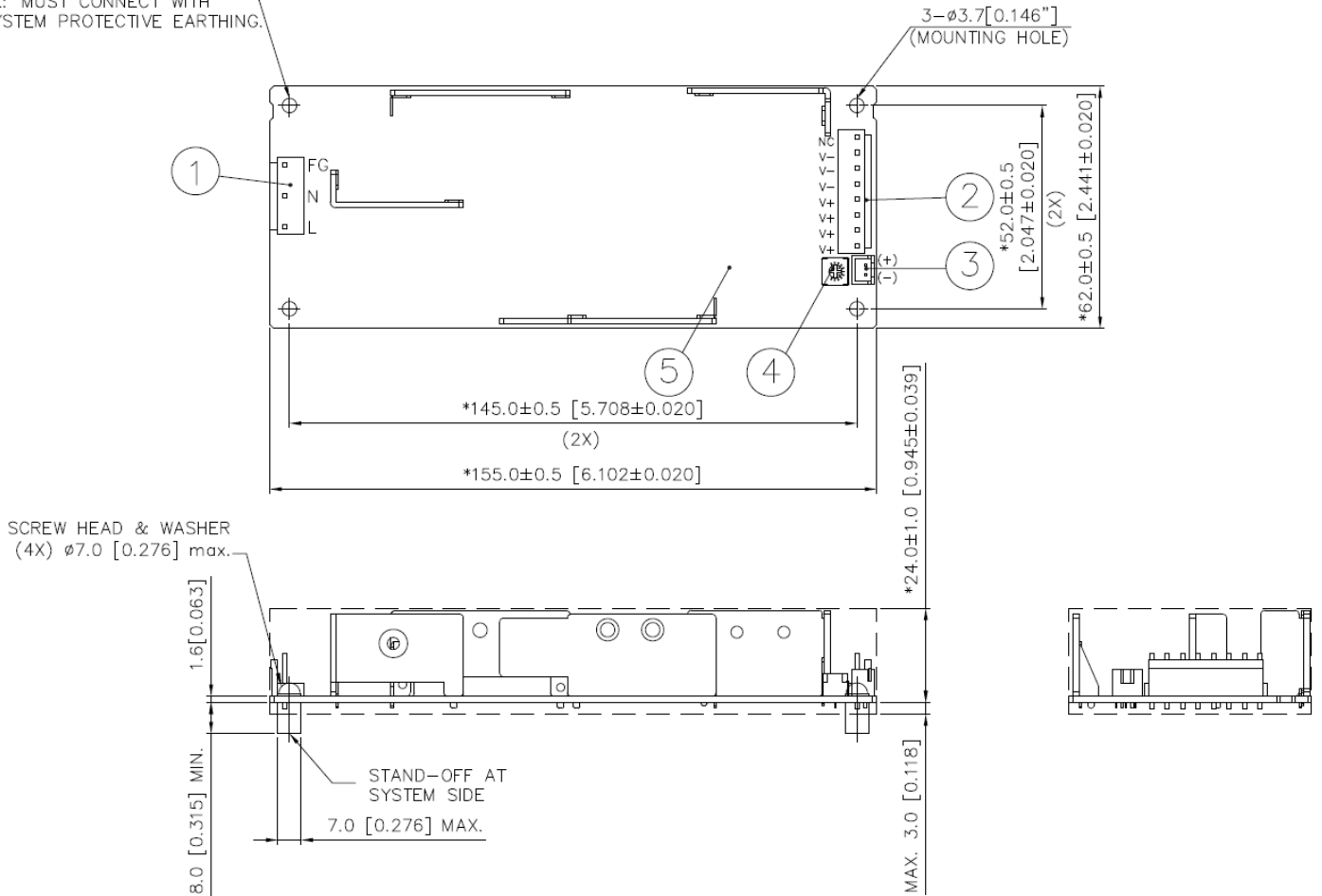

Item	Device Description
1	Input Connector
2	Output Connector
3	Remote ON/OFF (JST B2B-XH-A)
4	VR
5	PWB

Notes

- Dimensions are in mm
- For information on Mounting Torque, and I/O Connector and Housing, please refer to the Instruction Manual.
- For Open Frame type: There are 4 normal mounting holes.

PJ 2nd Generation Open Frame Power Supply

PJ-100W series 1 Phase / PJ-□□V100W□RA

Enclosed

L x W x H: 185 x 72 x 45 mm (7.28 x 2.83 x 1.77 inch)

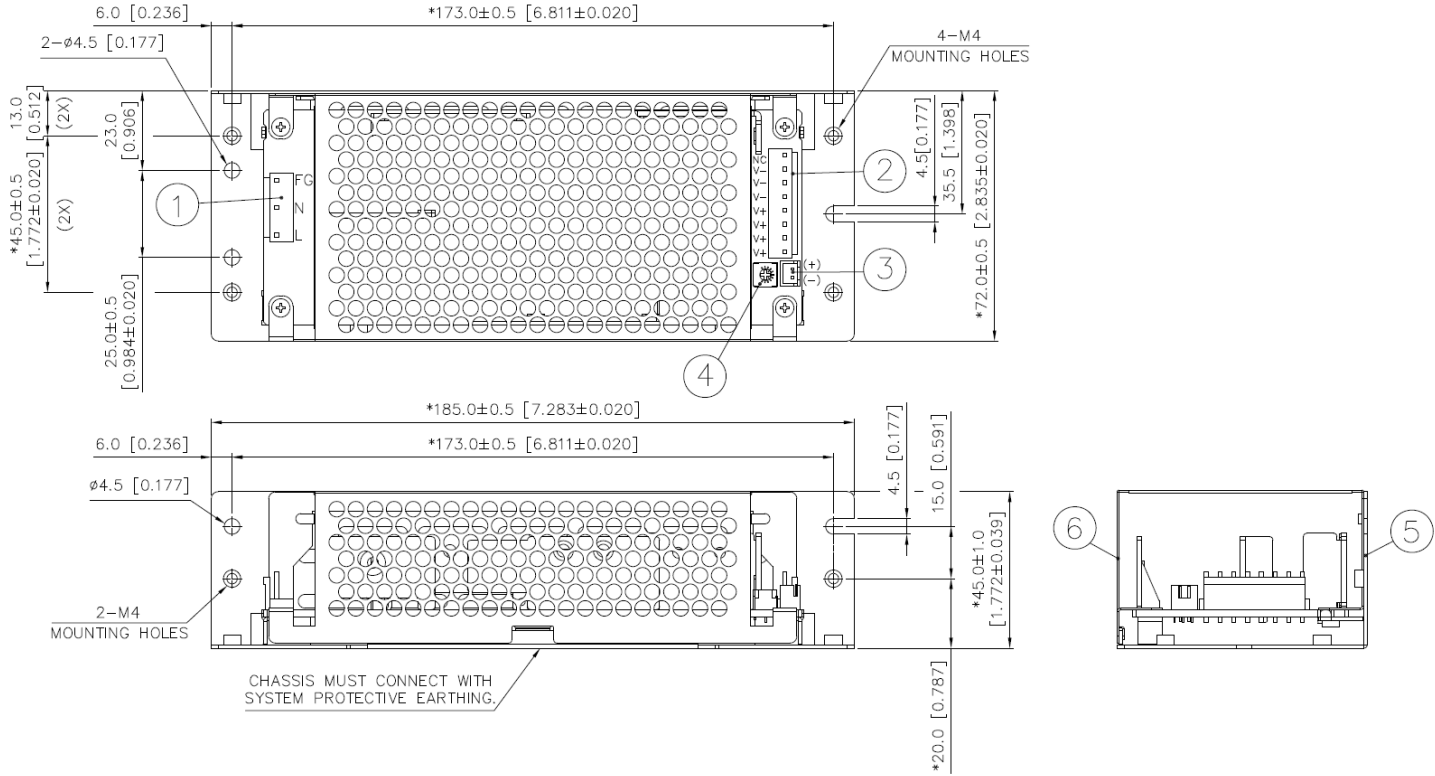

Item	Device Description
1	Input Connector
2	Output Connector
3	Remote ON/OFF (JST B2B-XH-A)
4	VR
5	Chassis
6	Cover

Notes

- Dimensions are in mm
- For information on Mounting Torque, and I/O Connector and Housing, please refer to the Instruction Manual.
- For Enclosed type: There are 6 threaded mounting holes and 5 normal mounting holes.

PJ 2nd Generation Open Frame Power Supply

PJ-100W series 1 Phase / PJ-□□V100W□RA

Assembly & Installation

Assembly Reference

■ Open Frame

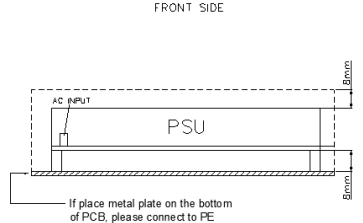
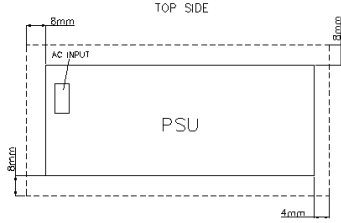

■ L Frame / Enclosed

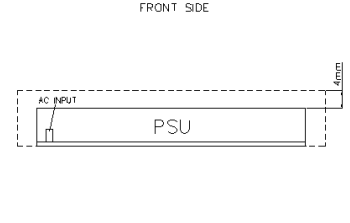
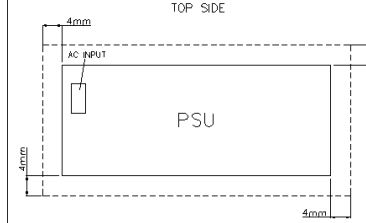

For safety reasons, please ensure the mounted device is kept safety distance as below at all sides from other components and equipments.

- a) For Open Frame Type ≥ 8 mm (0.315 inch) from primary side and ≥ 4 mm (0.16 inch) from secondary side.
- b) For with Case Type ≥ 4 mm (0.16 inch)

Please insert an insulation sheet between the system and product, if the safety distance is less than 4 mm (0.16 inch).

- Use flexible cable (stranded or solid) of AWG No. 22-18. Please refer to Table 1 for the recommended Housing and Terminal.
- For the Remote ON/OFF function, use flexible cable (stranded or solid) of AWG No. 28-22.

Table 1

	Connector (Board Mounting)	Housing	Terminal
Input (JST)	B3P5-VH(LF)(SN)	VHR-5N	SVH-21T-P1.1
Output (JST)	B8P-VH(LF)(SN)	VHR-8N	
Remote ON/OFF Function	B2B-XH-A(LF)(SN)	XHP-2	SXH-001T-P0.6

PJ 2nd Generation Open Frame Power Supply

PJ-100W series 1 Phase / PJ-□□V100W□RA

Mounting Orientation

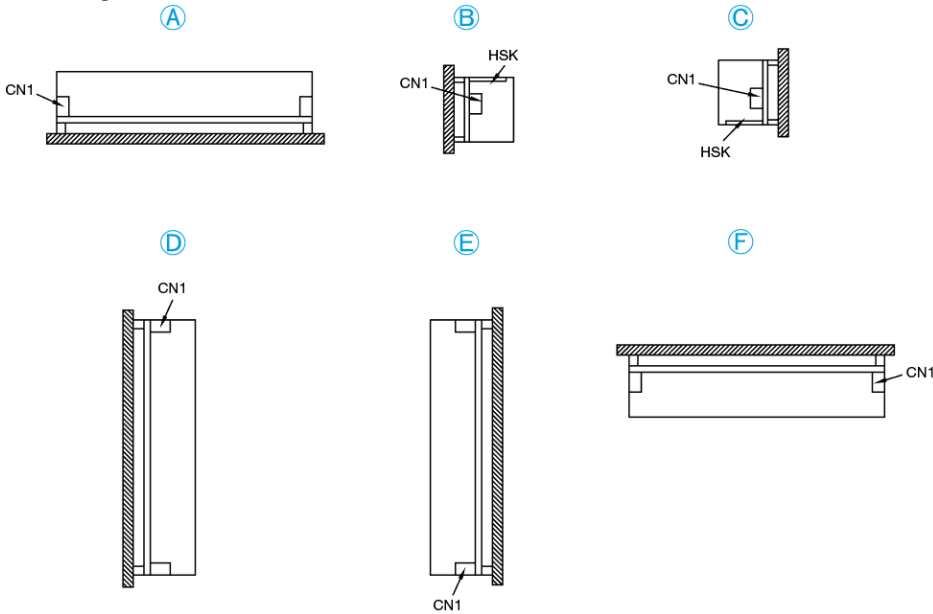

- Any excessive twisting or bending may damage the device's PCB. Please handle the device with care.
- The device is not recommended to be placed on low thermal conductive surfaces. For example, plastics.
- Prevent any foreign metal, particles or conductors from entering the device through the openings during installation. It may cause: -Electric shock; Safety hazard; Product failure.
- **The power supply must be mounted by metal screws onto a grounded metal surface. It is highly recommended that the Earth terminal on the connector be connected to the grounded metal surface.**

Engineering Data

Convection

Output Load De-rating VS Surrounding Air Temperature

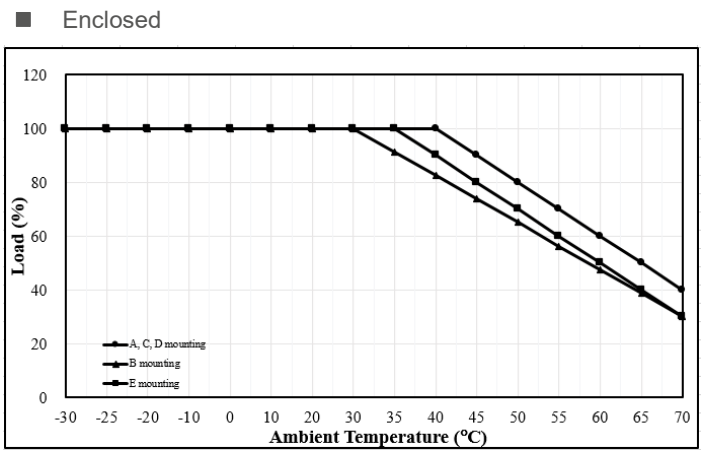
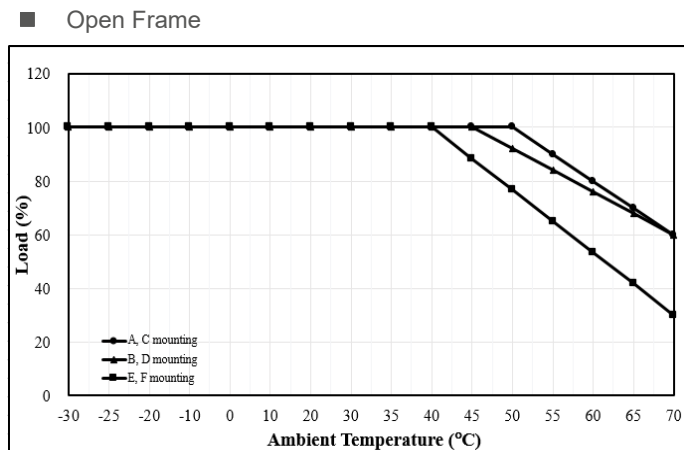

Fig.1.1 De-rating for Mounting Orientation A, C
 > 50°C de-rate power by 2% / °C
 De-rating for Mounting Orientation B, D
 > 45°C de-rate power by 2.67% / °C
 De-rating for Mounting Orientation E, F
 > 40°C de-rate power by 2.33% / °C

Fig.1.2 De-rating for Mounting Orientation A, C, D
 > 40°C de-rate power by 2% / °C
 De-rating for Mounting Orientation B
 > 30°C de-rate power by 1.75% / °C
 De-rating for Mounting Orientation E
 > 35°C de-rate power by 2% / °C

PJ 2nd Generation Open Frame Power Supply

PJ-100W series 1 Phase / PJ-□□V100W□RA

Forced Cooling (Air Velocity > 0.7 m/s)

Output Load De-rating VS Surrounding Air Temperature

■ Air Flow Direction

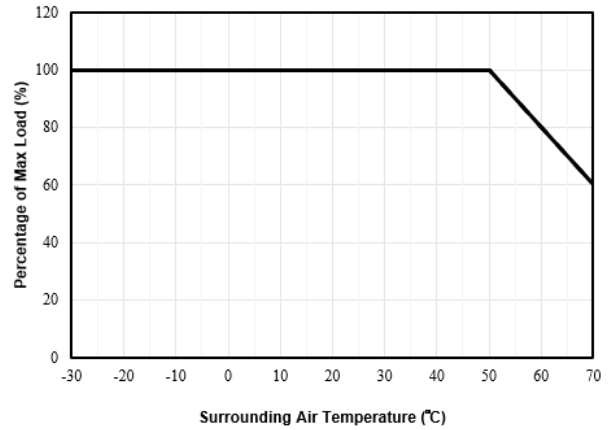
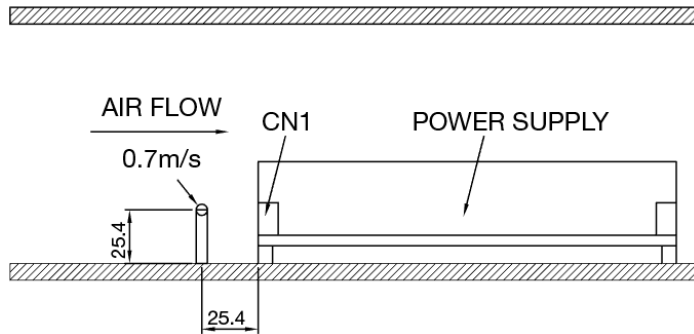

Fig. 1.3 De-rating for Mounting Orientation A to F
> 50°C de-rate power by 2% / °C

Notes

1. Power supply components may degrade, or be damaged, when the power supply is continuously used outside the shaded region, refer to the graphs shown above.
2. If the output capacity is not reduced when the surrounding air temperature is more than the upper limit temperature, the device will run into Over Temperature Protection. When activated, the output voltage will go into bouncing mode and will recover when the surrounding air temperature is lowered or the load is reduced as far as necessary to keep the device in working condition.
3. Depending on the surrounding air temperature and output load delivered by the power supply, the device housing can be very hot!
4. If the device has to be mounted in any other orientation, please leave a message via the [Contact Us](#) form.

PJ 2nd Generation Open Frame Power Supply

PJ-100W series 1 Phase / PJ-□□V100W□RA

Output Load De-rating VS. Input Voltage

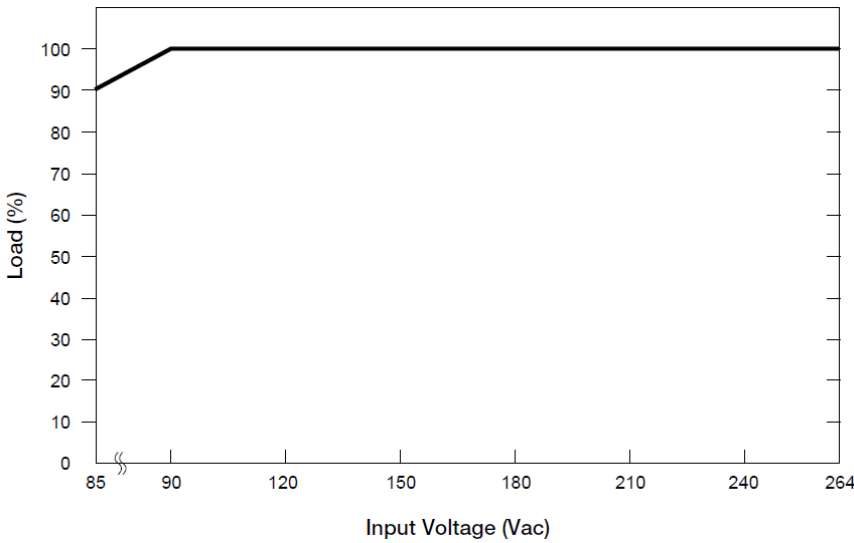

■ No output power de-rating for the input voltage range from 90 Vac to 264 Vac

Fig.1.4 De-rating for Mounting Orientation A to F
 < 90 Vac de-rate power by 2% / V

Functional Manual

Remote ON/OFF Function

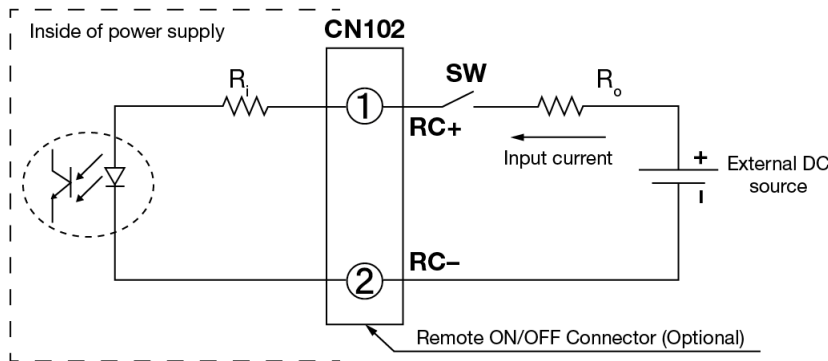

You can remotely control the power supply unit to turn ON/OFF by using an external DC source. Follow the DC power source voltage and current limiting defined in the table below.

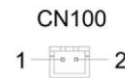

PIN NO.	FUNCTION
1	Remote ON/OFF(+)
2	Remote ON/OFF(-)

Built-in Resistor R_i (ohm)	Voltage Between RC+ and RC- (V)		Input Current (mA)
	Output ON	Output OFF	
1.5 k	0-0.5V	5-12.5V	20mA Max

Notes

1. Remote ON/OFF circuits are isolated from input, output and PE.
2. Please check if the polarity of the wire connector is the same as the external DC source. If not, the power would not turn on and the internal components may be damaged.
3. You do not need an external resistance R_0 for current limit while the output voltage of external DC source is within the range of 5-12.5 V. If the output voltage exceeds 12.5 V, please use the following equation for the value of current limit resistance R_0 .

$$R_0 = \frac{V_{cc} - (3.5 + 0.006R_i)}{0.006}$$

PJ 2nd Generation Open Frame Power Supply

PJ-100W series 1 Phase / PJ-□□V100W□RA

Functions

Start-up Time

The time required for the output voltage to reach 90% of its final steady state set value, after the input voltage is applied.

Rise Time

The time required for the output voltage to change from 10% to 90% of its final steady state set value.

Hold-up Time

Time between the collapse of the AC input voltage, and the output falling to 95% of its steady state set value.

■ Graph illustrating the Start-up Time, Rise Time, and Hold-up Time

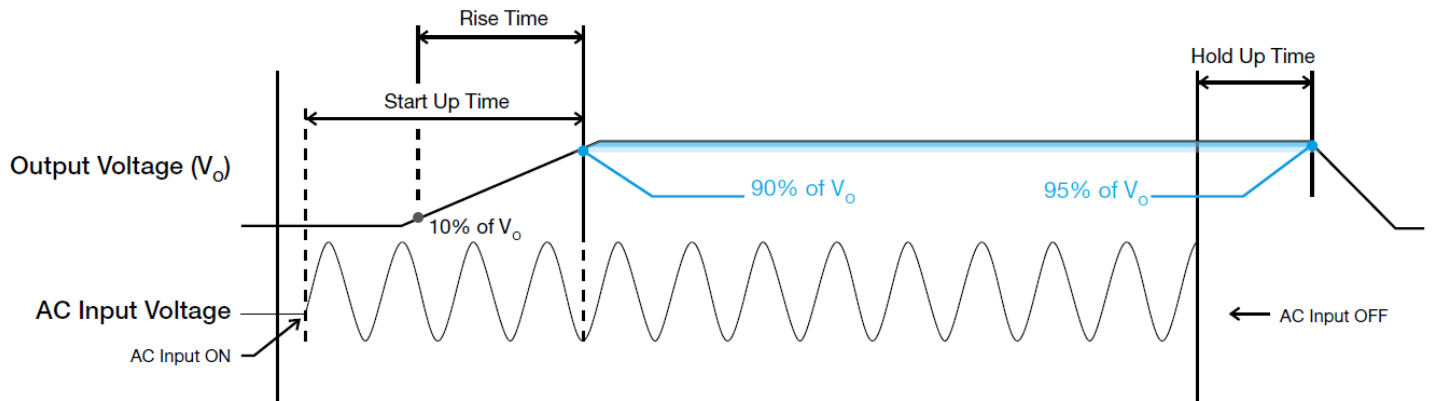

PJ 2nd Generation Open Frame Power Supply

PJ-100W series 1 Phase / PJ-□□V100W□RA

Dynamic Response

The power supply output voltage will remain within $\pm 5\%$ of its steady state value, when subjected to a dynamic load from 0 to 50% and 50 to 100% of its rated current.

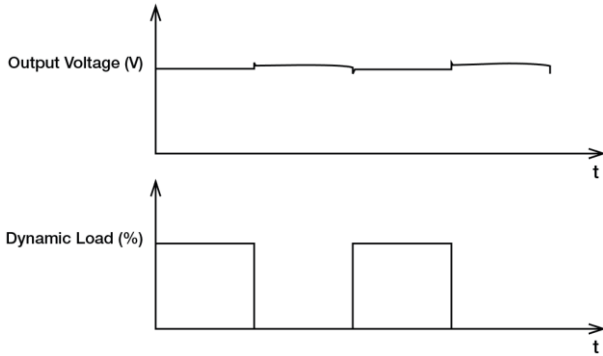

Inrush Current

Inrush current is the peak, instantaneous, input current measured and, occurs when the input voltage is first applied. For AC input voltages, the maximum peak value of inrush current will occur during the first half cycle of the applied AC voltage. This peak value decreases exponentially during subsequent cycles of AC voltage.

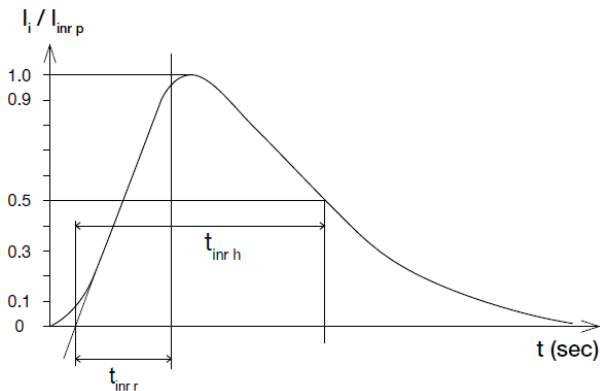

Overvoltage Protection (Latch Mode)

The power supply's overvoltage circuit will be activated when its internal feedback circuit fails. The output voltage shall not exceed its specifications defined on Page 3 under "Protections". Power supply will latch off, and require removal/re-application of input AC voltage in order to restart. **The power supply should be latch.**

Short Circuit Protection (Auto-Recovery)

The power supply's output OLP/OCP function also provides protection against short circuits. When a short circuit is applied, the output current will operate in "Hiccup mode", as shown in the illustration in the OLP/OCP section on this page. The power supply will return to normal operation after the short circuit is removed.

Overload & Overcurrent Protections (Auto-Recovery)

The power supply's Overload (OLP) and Overcurrent (OCP) Protections will be activated when output current exceeds 201% of I_o (Max load). In such occurrence, the V_o will start to droop and once the power supply has reached its maximum power limit, the protection is activated and the power supply will go into "Hiccup mode" (Auto-Recovery). The power supply will recover once the fault condition of the OLP and OCP is removed and I_o is back within the specifications.

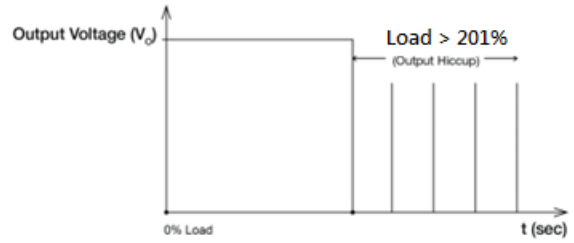

It is not recommended to prolong the duration of I_o when it is 201% but >100%, since it may cause damage to the PSU.

Over Temperature Protection (Latch Mode)

As described in load de-rating section, the power supply also has Over Temperature Protection (OTP). In the event of a higher operating temperature at 100% load; or, when the operating temperature is beyond what is recommended in the de-rating graph, the OTP circuit will be activated. When activated, power supply will latch off, until the surrounding air temperature drops to its normal operating temperature or the load is reduced as recommended in the de-rating graph. Removal/re-application of input AC voltage will then be required in order to restart.

PJ 2nd Generation Open Frame Power Supply

PJ-100W series 1 Phase / PJ-□□V100W□RA

Power Boost

Power Boost is the reserve power available constantly that allows reliable startup to support sudden and short spike of loads with high inrush current typically during turn on to remove the need of more expensive higher rated power supply unit. After the output has reached its steady state set value, the power supply can support surge loads with a higher short-term power demand up to 200% of maximum rated load (I_o Max), for a maximum duration of 10 seconds. The Power Boost is also available to repeatedly basis with according to the condition of an average (R.M.S) output power shall not exceed continuous operating condition or refer to duty cycle calculation below.

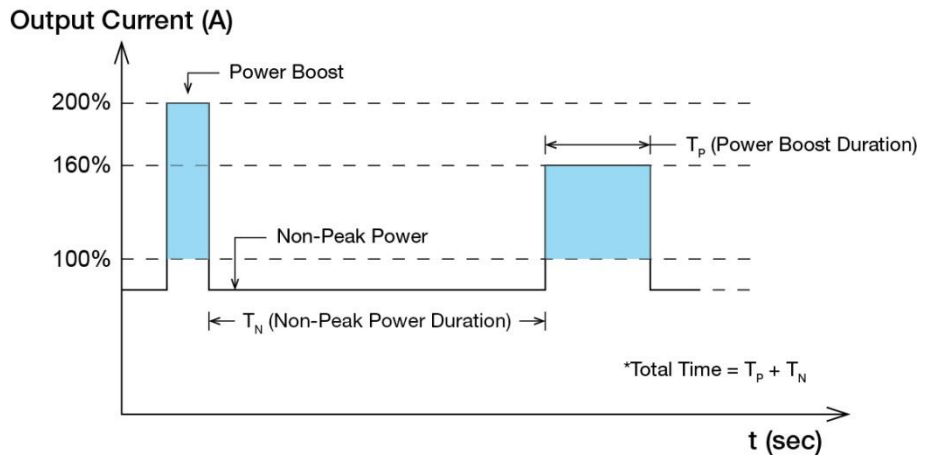

Fig. 2 Duty Cycle Calculation

$$I_{rms} \leq \text{Rated current}$$

$$\text{Duty} = \frac{t_P}{t_P + t_N} \times 100[\%] \leq 40\%$$

$$I_{rms}^2 = \frac{I_{Power\ Boost}^2 \times t_P + I_{Non_Power\ Boost}^2 \times t_N}{t_P + t_N}$$

$$I_{Non_Power\ Boost} = \sqrt{\frac{I_{rms}^2 \times (t_P + t_N) - I_{Power\ Boost}^2 \times t_P}{t_N}}$$

■ An example of Power Boost and Average Output Power

Power Boost	Peak Power (W _P)	Power Boost Duration (T _P)	Duty Cycle	Non-Peak Power (W _N)	Non-Peak Power Duration (T _N)	Total Time (T)
200%	206.4 W	10 sec	15%	70.8 W	57 sec	67 sec
200%	206.4 W	5 sec	15%	70.8 W	28 sec	33 sec
150%	154.8 W	10 sec	40%	42.1 W	15 sec	25 sec
150%	154.8 W	5 sec	40%	42.1 W	7.5 sec	12.5 sec

It is not recommended to prolong the duration of Power Boost to be longer than the specified duty cycle calculation, this may cause damage to the PSU.

PJ 2nd Generation Open Frame Power Supply

PJ-100W series 1 Phase / PJ-□□V100W□RA

Others

Conformal Coating

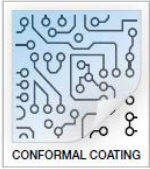

The Protective Coating Technology

Delta Electronics Group has designed the perfect dipping technique which penetrates everywhere including under device, and prevents leakage. The conformal coating dipping can be applied to PCBs or circuit board. The coating preserves the performance of precision electronic primarily by preventing ionizable contaminants such as salt from reaching circuit nodes, where the material slumps around sharp edges. This can be a problem especially in highly conversing atmosphere.

Attention

Delta provides all information in the datasheets on an "AS IS" basis and does not offer any kind of warranty through the information for using the product. In the event of any discrepancy between the information in the catalog and datasheets, the datasheets shall prevail (please refer to www.DeltaPSU.com for the latest datasheets information). Delta shall have no liability of indemnification for any claim or action arising from any error for the provided information in the datasheets. Customer shall take its responsibility for evaluation of using the product before placing an order with Delta.

Delta reserves the right to make changes to the information described in the datasheets without notice.

Manufacturer and Authorized Representatives Information

Manufacturer

Thailand

Delta Electronics (Thailand) PCL.
909 Pattana 1 Rd., Muang, Samutprakarn, 10280 Thailand

Taiwan

Delta Electronics, Inc.
3 Tungyuan Road, Chungli Industrial Zone, Taoyuan County
32063, Taiwan

Authorized Representatives

The Netherlands

Delta Greentech (Netherlands) B.V.
Zandsteen 15, 2132 MZ Hoofddorp, The Netherlands

United Kingdom

Delta Electronics Europe Limited
1 Redwood Court, Peel Park Campus,
East Kilbride, Glasgow, G74 5PF, United Kingdom